

INSTRUCTION GUIDE

Oatey

45° ELBOW

- 1** Measure and cut both drains **(D)** to required length (They should be cut to a length that allows them to stop fully inside the 45°s **(C)** socket.)
- 2** Position nut **(A)** then washer **(B)** on both drains **(D)**.
- 3** Attach drains **(D)** into 45° **(C)** while making sure they are fully inside the sockets.
- 4** Tighten all nuts **(A)**. **CHECK FOR LEAKS.**

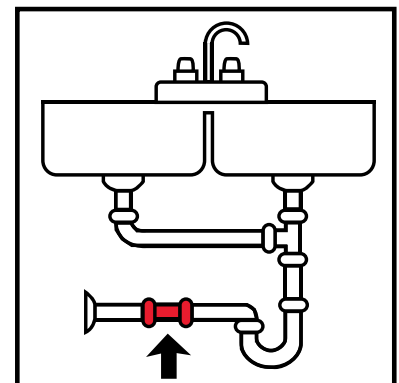
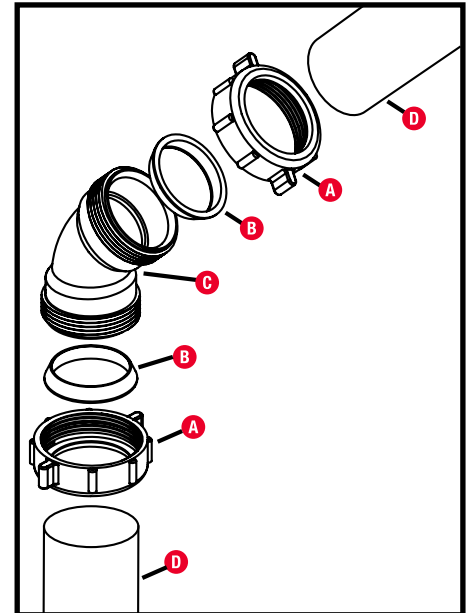

©2023 Oatey SCS. All Rights Reserved. This information is based on data believed to be reliable but Oatey makes no warranties, express or implied, as to its accuracy and assumes no liability arising out of its use. The data listed falls within the normal range of product properties but should not be used to establish specification limits or used alone as the basis of design. Oatey's liability to purchasers is expressly limited to the terms and conditions of sale. Oatey is trademark of Oatey Co. All other trademarks can be found www.Oatey.com.